

REV.	ECN NO.	DESCRIPTION	DESIGN	DATE
A		INITIAL	Kai	2018.03.29

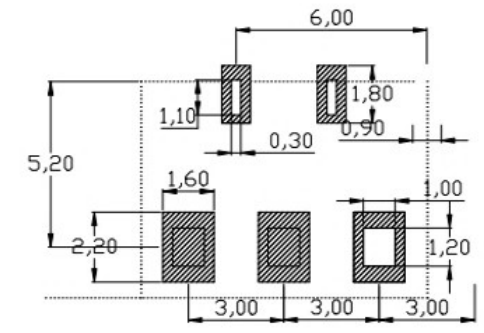

RECOMMENDED PCB LAYOUT
TOP VIEW(.XX±0.05)

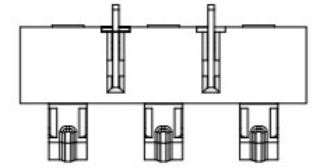
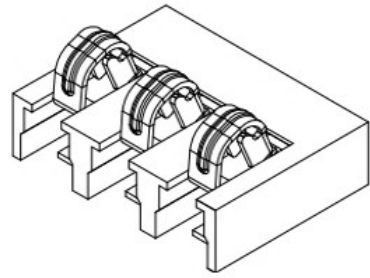
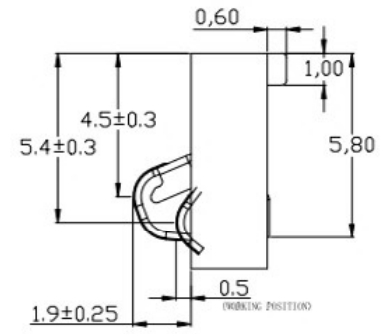
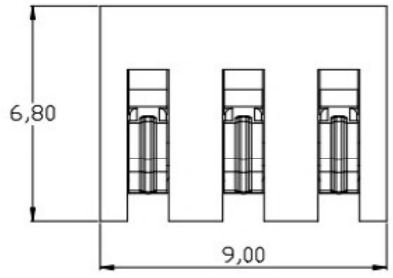

性能:
 额定电流: 3.0A
 额定电压: 24V
 耐电压: 500V
 接触电阻: 30mΩ MAX
 绝缘电阻: 500MΩ
 工作温度: -40℃~+85℃
 塑件(材质): LCP, 耐高温260℃
 接触点(材质): 铜合金, 触点镀金3U'

DIM A	DIM B
2.4	4.30±0.25
3.5	5.40±0.25

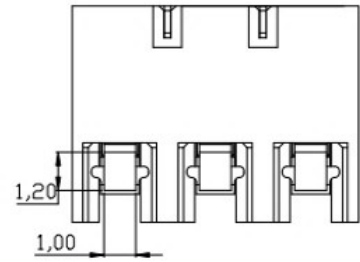
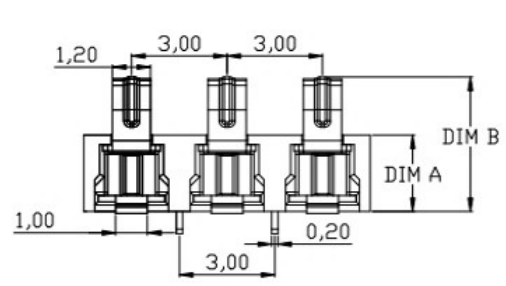

UNLESS OTHERWISE SPECIFIED TOLERANCES

DECIMALS:		ANGLES:	
DIM	TOL	DIM	TOL
X.	±0.50	X.	±2°
X.X	±0.30	X.X	±1°
X.XX	±0.20	X.XX	---
X.XXX	±0.10	X.XXX	---

东莞市铀高电子制品有限公司

DWG NO.	PART NAME:
DESIGN:	PART NO.
CHECK:	REV. A
APPROVED	UNIT: mm
	SHEET: 1/1

②	HOUSING	1	LCP		BLACK
①	CONTACT A	2	PHOSPHOR BRONZE 0.20T	Au PLATED	
ITEM	PART NAME	Q'TY	MATERTAL	DESCRIPTION	REMARK