

| | | | | |
|------|---------|-------------|--------|------------|
| REV. | ECN NO. | DESCRIPTION | DESIGN | DATE |
| A | | INITIAL | Koi | 2018.03.29 |

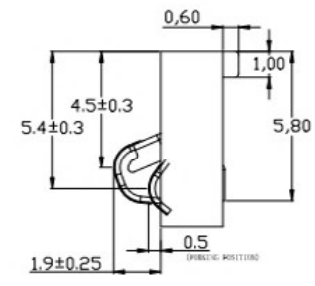

性能:
 额定电流: 3.0A
 额定电压: 24V
 耐压: 500V
 接触电阻: 30mΩ MAX
 绝缘电阻: 500MΩ
 工作温度: -40℃~+85℃
 塑件(材质): LCP, 耐高温260℃
 接触点(材质): 铜合金, 触点镀金3U

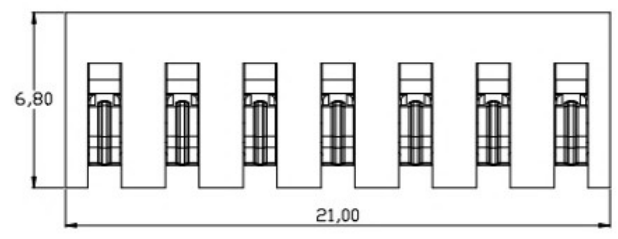
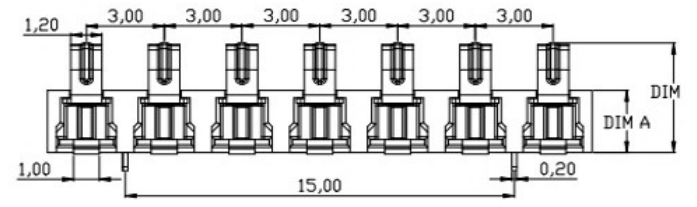
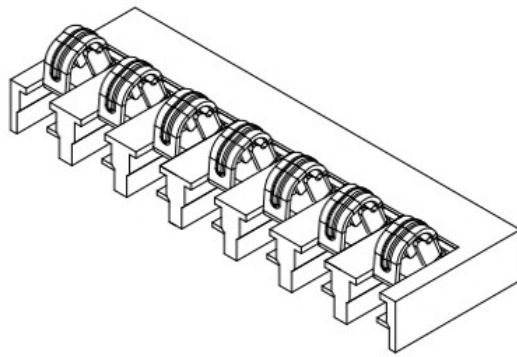
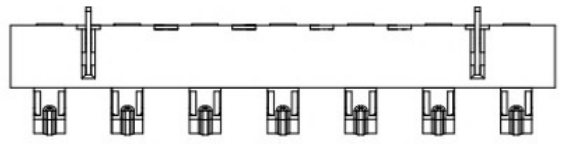
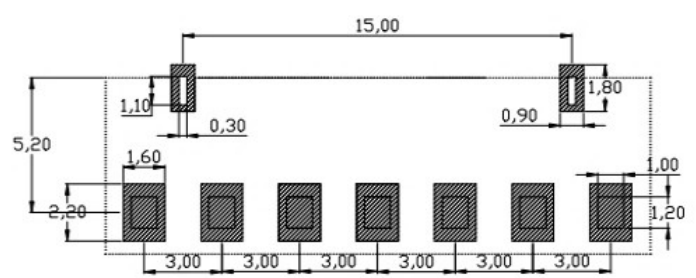
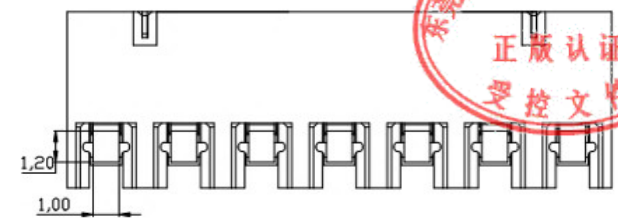
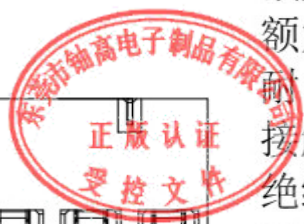

RECOMMENDED PCB LAYOUT
 TOP VIEW (.XX±0.05)

| | | | | | | | |
|---------------------------------------|-------|---------|-----|---------------|-------------------|----|-----|
| UNLESS OTHERWISE SPECIFIED TOLERANCES | | | | 东莞市铀高电子制品有限公司 | | | |
| DECIMALS: | | ANGLES: | | DWG NO. | PART NAME: | | |
| DIM | TOL | DIM | TOL | DESIGN: | PART NO. | | |
| X. | ±0.50 | X. | ±2° | CHECK: | REV. UNIT: SHEET: | | |
| X.X | ±0.30 | X.X | ±1° | APPROVED | A | mm | 1/1 |
| X.XX | ±0.20 | X.XX | --- | | | | |
| X.XXX | ±0.10 | X.XXX | --- | | | | |

| | | | | | |
|------|-----------|------|-----------------------|-------------|--------|
| ② | HOUSING | 1 | LCP | | BLACK |
| ① | CONTACT A | 2 | PHOSPHOR BRONZE 0.20T | Au PLATED | |
| ITEM | PART NAME | Q'TY | MATERTAL | DESCRIPTION | REMARK |