

RoHS  
Compliant  
2002/95/EC

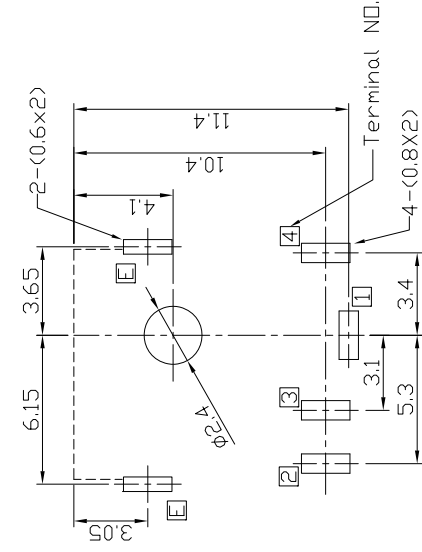

### PCB. 焊接图

PCB WELDING DRAWING

### 主要技术参数、性能

额定电流、电压	3A DC20V
接触电阻	≤ 50mΩ
绝缘电阻	≥ 100MΩ
耐电压	500VAC
插拔力	3-30N
寿命	5000次
温度范围	-20°C~70°C
湿度范围	-40°C~85°C

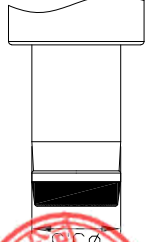
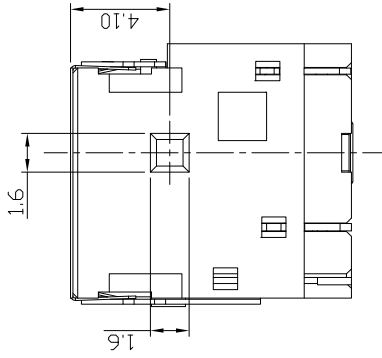
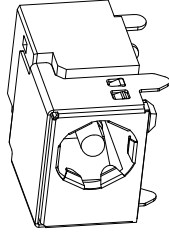

DC MATE PLUG

Model No.	G	H	J
CENTER PIN	ø1.65	ø2.0	ø2.5

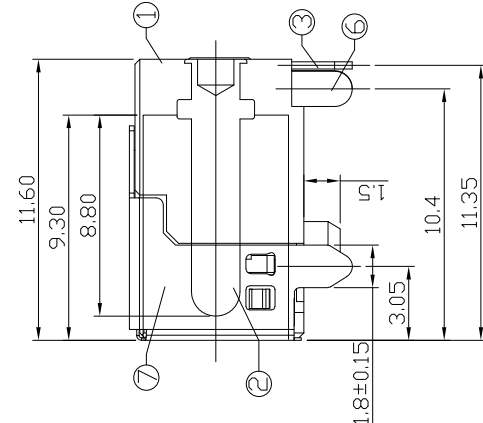
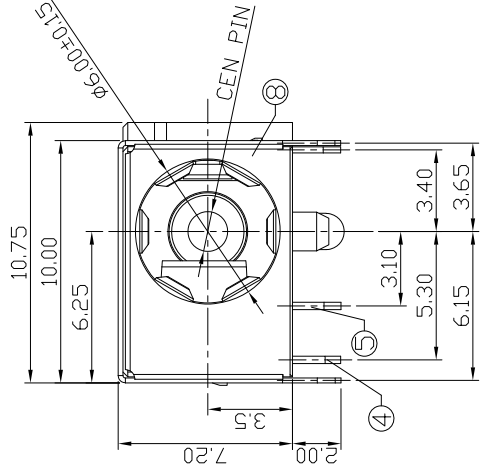
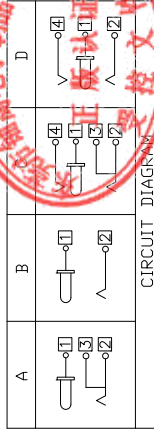

项目	名称	材质	数量	表面处理/颜色
8	Shield Plate E	Stainless Steel	1	
7	Ground shield E	Brass	1	
6	Tip Spring-2 4	Phospor Bronze	1	
5	Shunt Terminal 3	Brass	1	
4	Tip Spring-1 2	Phospor Bronze	1	
3	Center Pin Terminal 1	Brass	1	
2	Center Pin	Brass	1	
1	Housing	PA9T/PA10T	1	Black
		数量	3	表面处理/颜色

### 一般公差

Nickel plating	±0.10
Silver plating	±0.25
Silver plating	±0.30
Silver plating	±3°

THESE DRAWINGS AND SPECIFICATIONS ARE THE PROPERTY OF ACCURATE INNOTECH INC. AND SHALL NOT BE REPRODUCED OR USED IN ANY MANNER WITHOUT THE PRIOR WRITTEN CONSENT OF ACCURATE INNOTECH INC.

绘图	杨瑛平	产品名称	DC JACK
审核	郑金钰	产品型号	YG-DCB0-044LA
批准	林进生	日期	2023.05.19
SHEET	1:1 UNIT mm		

东莞市铷高电子有限公司